



Dell™ Latitude™ X300 and Inspiron™ 300m Media Base User's Guide

[Using the Media Base](#)
[Regulatory Notices](#)
[Limited Warranty and Return Policy](#)

Notes, Notices, and Cautions

-  **NOTE:** A NOTE indicates important information that helps you make better use of your computer.
 -  **NOTICE:** A NOTICE indicates either potential damage to hardware or loss of data and tells you how to avoid the problem.
 -  **CAUTION:** A CAUTION indicates a potential for property damage, personal injury, or death.
-

Information in this document is subject to change without notice.
© 2003 Dell Computer Corporation. All rights reserved.

Reproduction in any manner whatsoever without the written permission of Dell Computer Corporation is strictly forbidden.

Trademarks used in this text: *Dell*, the *DELL* logo, *Inspiron*, *Latitude*, and *TrueMobile* are trademarks of Dell Computer Corporation; *Microsoft* and *Windows* are registered trademarks of Microsoft Corporation. *ENERGY STAR* is a registered trademark of the U.S. Environmental Protection Agency. As an ENERGY STAR Partner, Dell Computer Corporation has determined that this product meets the ENERGY STAR guidelines for energy efficiency.

Other trademarks and trade names may be used in this document to refer to either the entities claiming the marks and names or their products. Dell Computer Corporation disclaims any proprietary interest in trademarks and trade names other than its own.

Model PR04S

May 2003 P/N W1500 Rev. A00

Using the Media Base

Dell™ Latitude™ X300 and Inspiron™ 300m Media Base User's Guide

- [Safety Instructions](#)
- [When Using Your Media Base](#)
- [Finding Information](#)
- [About Your Media Base](#)
- [Setting Up Your Media Base](#)
- [Securing the Media Base](#)
- [Installing a Battery](#)
- [Docking Your Computer](#)
- [Undocking Your Computer](#)
- [Installing Drives](#)
- [Removing Drives](#)
- [Connecting and Disconnecting External Drives](#)
- [Swapping External Drives While the Computer Is Running](#)
- [Specifications](#)

1 If your computer includes an integrated or optional (PC Card) modem, disconnect the modem cable if an electrical storm is approaching to avoid the remote risk of electric shock from lightning via the telephone line.



CAUTION: Safety Instructions

Use the following safety guidelines to help ensure your own personal safety and to help protect your media base and working environment from potential damage.

General

- 1 Do not attempt to service the media base yourself unless you are a trained service technician. Always follow installation instructions closely.
- 1 If you use an extension power cable with your AC adapter, ensure that the total ampere rating of the products plugged in to the extension power cable does not exceed the ampere rating of the extension cable.
- 1 Do not push objects into air vents or openings of your media base. Doing so can cause fire or electric shock by shorting out interior components.
- 1 Do not store your media base in a low-airflow environment, such as a carrying case or a closed briefcase, while the media base is turned on. Restricting airflow can damage the media base or cause a fire.
- 1 Keep your media base away from radiators and heat sources. Also, do not block cooling vents. Avoid placing loose papers underneath your media base; do not place your media base in a closed-in wall unit or on a bed, sofa, or rug.
- 1 Place the AC adapter in a ventilated area, such as a desk top or on the floor, when you use it to run the media base or to charge the battery. Do not cover the AC adapter with papers or other items that will reduce cooling; also, do not use the AC adapter inside a carrying case.
- 1 The AC adapter may become hot during normal operation of your media base. Use care when handling the adapter during or immediately after operation.
- 1 Do not allow your portable media base to operate with the base resting directly on exposed skin for extended periods of time. The surface temperature of the base will rise during normal operation (particularly when AC power is present). Allowing sustained contact with exposed skin can cause discomfort or, eventually, a burn.
- 1 Do not use your media base in a wet environment, for example, near a bath tub, sink, or swimming pool or in a wet basement.

- 1 To help avoid the potential hazard of electric shock, do not connect or disconnect any cables or perform maintenance or reconfiguration of this product during an electrical storm. Do not use your computer during an electrical storm unless all cables have been disconnected and the computer is operating on battery power.
- 1 If your computer includes a modem, the cable used with the modem should be manufactured with a minimum wire size of 26 American wire gauge (AWG) and an FCC-compliant RJ-11 modular plug.
- 1 Before you clean your media base, disconnect the media base from the electrical outlet. Clean your media base with a soft cloth dampened with water. Do not use liquid or aerosol cleaners, which may contain flammable substances.

Power

- 1 Use only the Dell-provided AC adapter approved for use with this media base. Use of another AC adapter may cause a fire or explosion.
- 1 Before you connect the media base to an electrical outlet, check the AC adapter voltage rating to ensure that the required voltage and frequency match the available power source.
- 1 To remove the media base from all power sources, turn the computer off, disconnect the AC adapter from the electrical outlet, and remove any battery installed in the battery bay.
- 1 To help prevent electric shock, plug the AC adapter and device power cables into properly grounded power sources. These power cables may be equipped with 3-prong plugs to provide an earth grounding connection. Do not use adapter plugs or remove the grounding prong from the power

cable plug. If you use a power extension cable, use the appropriate type, 2-prong or 3-prong, to mate with the AC adapter power cable.

- 1 Be sure that nothing rests on your AC adapter's power cable and that the cable is not located where it can be tripped over or stepped on.
- 1 If you are using a multiple-outlet power strip, use caution when plugging the AC adapter's power cable into the power strip. Some power strips may allow you to insert the plug incorrectly. Incorrect insertion of the power plug could result in permanent damage to your media base, as well as risk of electric shock and/or fire. Ensure that the ground prong of the power plug is inserted into the mating ground contact of the power strip.

Battery

- 1 Use only Dell™ battery modules that are approved for use with this media base. Use of other types may increase the risk of fire or explosion.
- 1 Do not carry a battery pack in your pocket, purse, or other container where metal objects (such as car keys or paper clips) could short-circuit the battery terminals. The resulting excessive current flow can cause extremely high temperatures and may result in damage to the battery pack or cause fire or burns.
- 1 The battery poses a burn hazard if you handle it improperly. Do not disassemble it. Handle a damaged or leaking battery pack with extreme care. If the battery is damaged, electrolyte may leak from the cells and may cause personal injury.
- 1 Keep the battery away from children.
- 1 Do not store or leave your media base or battery pack near a heat source such as a radiator, fireplace, stove, electric heater, or other heat-generating appliance or otherwise expose it to temperatures in excess of 60°C (140°F). When heated to excessive temperatures, battery cells could explode or vent, posing a risk of fire.
- 1 Do not dispose of your computer's battery in a fire or with normal household waste. Battery cells may explode. Discard a used battery according to the manufacturer's instructions or contact your local waste disposal agency for disposal instructions. Dispose of a spent or damaged battery promptly.

Air Travel

- 1 Certain Federal Aviation Administration regulations and/or airline-specific restrictions may apply to the operation of your Dell computer while you are on board an aircraft. For example, such regulations/restrictions may prohibit the use of any personal electronic device (PED) that has the capacity for intentional transmission of radio frequency or other electromagnetic signals while on an aircraft.
 - o In order to best comply with all such restrictions, if your Dell portable computer is equipped with Dell TrueMobile™ or some other wireless communication device, please disable this device before you board the aircraft and follow all instructions provided by airline personnel with regard to such device.
 - o Additionally, the use of any PED, such as a portable computer, may be prohibited in aircraft during certain critical phases of flight, for example, takeoff and landing. Some airlines may further define the critical flight phase as any time the aircraft is below 3050 m (10,000 ft). Please follow the airline's specific instructions as to when the use of a PED is allowed.

EMC Instructions

Use shielded signal cables to ensure that you maintain the appropriate electromagnetic compatibility (EMC) classification for the intended environment. For parallel printers, a cable is available from Dell. If you prefer, you can order a cable from Dell at its worldwide website at www.dell.com.

Static electricity can harm electronic components inside your media base. To prevent static damage, discharge static electricity from your body before you touch any of your media base's electronic component. You can do so by touching an unpainted metal surface on the media base's input/output panel.

WARNING: Handling the cord on this product, or cords associated with accessories sold with this product, will expose you to lead, a chemical known to the State of California to cause birth defects or other reproductive harm. **Wash your hands after handling the cord.**

When Using Your Media Base

Observe the following safe-handling guidelines to prevent damage to your media base:

- 1 When setting up the media base for work, place it on a level surface.
- 1 When traveling, do not check the media base as baggage. You can put your media base through an X-ray security machine, but never put your media base through a metal detector.
- 1 When traveling, do not place the media base in overhead storage compartments where it could slide around. Do not drop your media base or subject it to other mechanical shocks.
- 1 Protect your media base, battery, and hard drive from environmental hazards such as dirt, dust, food, liquids, temperature extremes, and overexposure to sunlight.
- 1 When you move your media base between environments with very different temperature and/or humidity ranges, condensation may form on or within the media base. To avoid damaging the media base, allow sufficient time for the moisture to evaporate before using the media base.

NOTICE: When taking the media base from low-temperature conditions into a warmer environment or from high-temperature conditions into a cooler environment, allow the media base to acclimate to room temperature before turning on power.

- 1 When you disconnect a cable, pull on its connector or on its strain-relief loop, not on the cable itself. As you pull out the connector, keep it evenly aligned to avoid bending any connector pins. Also, before you connect a cable make sure both connectors are correctly oriented and aligned.
- 1 Handle components with care. Hold a component by its edges, not its pins.

- 1 If your media base gets wet or is damaged, follow the procedures described in "Solving Problems" in the documentation that came with your computer. If, after following these procedures, you confirm that your media base is not operating properly, contact Dell (see Contacting Dell in the documentation that came with your computer for the appropriate contact information).



Protecting Against Electrostatic Discharge



Static electricity can harm electronic components inside your media base. To prevent static damage, discharge static electricity from your body before you touch any of your media base's electronic components. You can do so by touching any unpainted metal surface on the back of the media base. Periodically touch any unpainted metal surface on the back of the media base to remove any static charge your body may have accumulated.

You can also take the following steps to prevent damage from electrostatic discharge (ESD):

- 1 When unpacking a static-sensitive component from its shipping carton, do not remove the component from the antistatic packing material until you are ready to install the component. Just before unwrapping the antistatic packaging, be sure to discharge static electricity from your body.
- 1 When transporting a sensitive component, first place it in an antistatic container or packaging.
- 1 Handle all sensitive components in a static-safe area. If possible, use antistatic floor pads and workbench pads.

Finding Information

What are you looking for?	Find It Here
<ul style="list-style-type: none"> 1 How to access tutorials and other how to information 1 How to get a copy of my invoice 1 How to extend my warranty 1 How to access Dell Support on my Windows desktop (U.S. only) 1 Additional documentation, tools, troubleshooting information, and links to online support resources 	<p>Dell Solution Center</p>  <p>On your Windows desktop</p>
<ul style="list-style-type: none"> 1 How to set up a printer 1 Additional information about setting up my computer 1 How to troubleshoot and solve problems 1 How to remove and install parts 1 Technical specifications 1 How to contact Dell 	<p>Dell™ Inspiron™ Owner's Manual</p>  <p>NOTE: This document is available as a PDF at support.dell.com.</p>
<ul style="list-style-type: none"> 1 How to set up my computer 1 Warranty information 1 Safety instructions 	<p>Dell™ Latitude™ System Information Guide</p>

	 <p>NOTE: This document is available as a PDF at support.dell.com.</p>
<ul style="list-style-type: none"> 1 Tips on using Microsoft® Windows® 1 How to play CDs and DVDs 1 How to use standby mode and hibernate mode 1 How to change my display resolution 1 How to clean my computer 	<p>Dell Inspiron Help File</p> <ol style="list-style-type: none"> 1. Click the Start button and click Help and Support. 2. Click User and system guides and click User's guides. 3. Click Inspiron Help.
<ul style="list-style-type: none"> 1 How to remove and replace parts 1 Technical specifications 1 How to configure system settings 1 How to troubleshoot and solve problems 	<p>Dell Latitude User's Guide</p> <p><i>Windows XP Help and Support Center</i></p> <ol style="list-style-type: none"> 1. Click the Start button and click Help and Support. 2. Click User's and system guides and click User's guides. <p><i>Microsoft Windows 2000</i></p>  <p>Double-click the User's Guides icon on your desktop.</p>
<ul style="list-style-type: none"> 1 Service Tag and Express Service Code 1 Microsoft Windows License Label 	<p>Service Tag and Microsoft Windows License</p> <p>These labels are located on your computer.</p>  <ol style="list-style-type: none"> 1 Use the Service Tag to identify your computer when you use support.dell.com or contact technical support. 1 Enter the Express Service Code to direct your call when contacting technical support. The Express Service Code is not available in all countries. 1 Use the number on the Microsoft Windows License Label if you reinstall your operating system.
<ul style="list-style-type: none"> 1 Latest drivers for my computer 1 Answers to technical service and support questions 1 Online discussions with other users and technical support 1 Documentation for my computer 	<p>Dell Support Website — support.dell.com</p> <p>The Dell Support website provides several online tools, including:</p> <ul style="list-style-type: none"> 1 Solutions — Troubleshooting hints and tips, articles from technicians, and online courses 1 Community — Online discussion with other Dell customers 1 Upgrades — Upgrade information for components, such as memory, the hard drive, and the operating system 1 Customer Care — Contact information, order status, warranty, and repair information 1 Downloads — Drivers, patches, and software updates 1 Reference — Computer documentation, product specifications, and white papers
<ul style="list-style-type: none"> 1 Service call status and support history 1 Top technical issues for my computer 1 Frequently asked questions 1 File downloads 1 Details on my computer configuration 1 Service contract for my computer 	<p>Dell Premier Support Website — premiersupport.dell.com</p> <p>The Dell Premier Support website is customized for corporate, government, and education customers. This website may not be available in all regions.</p>
<ul style="list-style-type: none"> 1 How to use Windows XP 1 Documentation for my computer 1 Documentation for devices (such as a modem) 	<p>Windows Help and Support Center</p> <ol style="list-style-type: none"> 1. Click the Start button and click Help and Support. 2. Type a word or phrase that describes your problem and click the arrow icon. 3. Click the topic that describes your problem. 4. Follow the instructions on the screen.

About Your Media Base

Front View

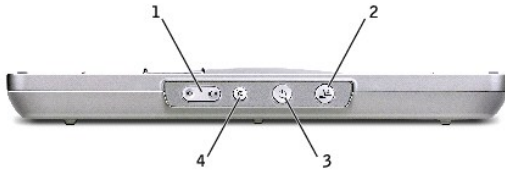

1	volume buttons
2	undock button
3	power button
4	mute button

volume buttons — Let you increase and decrease the volume.

undock button — Lets you undock your computer when your computer is operating.

power button — Lets you turn on and off your computer when it is docked.

mute button — Lets you mute the volume.

Left Side View

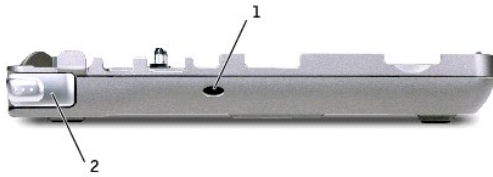

1	subwoofer tuned port vent
2	computer release latch

subwoofer tuned port vent — Provides air circulation for the tuned port.

computer release latch — Releases the computer from the media base if the media base is not secured by an antitheft device.

Right Side View

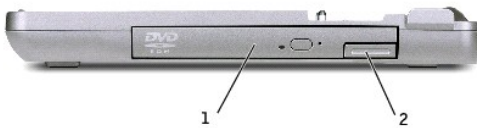

1	optical bay drive
2	device latch release button

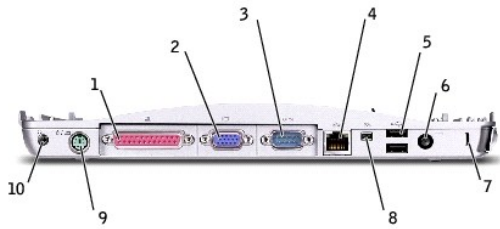

optical bay drive — Lets you use a variety of drives like a, DVD, CD, CD-RW, a floppy drive, or a second hard drive.

Back View



1	parallel connector	6	AC Adapter connector
2	video connector	7	security cable slot
3	serial connector	8	IEEE 1394 connector
4	RJ-45 network connector	9	PS/2 connector
5	USB 2.0 connectors	10	headphone connector

Connector	Description
	<p>parallel connector — Connects a parallel device, such as a parallel printer.</p>
	<p>video connector — Connects an external VGA monitor.</p> <p>NOTE: When your computer is docked, use the video connector on the media base.</p>
	<p>serial connector — Connects a serial device, such as a serial mouse or a handheld device.</p>
	<p>RJ-45 network connector — Connects the media base to a network.</p> <p>The network connector has status lights on both sides.</p> <p>If the light on the right is off, the media base is not detecting a network connection. Try replacing the network cable. The light on the right blinks yellow when the network is active.</p> <p>The light on the left indicates the link speed:</p> <p>Solid Green — Connection speed is 10 Mbps.</p> <p>Amber — Connection speed is 100 Mbps.</p> <p>Yellow — Connection speed is 1 Gbps.</p> <p>For information on using the network adapter, see the documentation that came with your computer.</p> <p>NOTICE: Do not plug a telephone cable into the network connector.</p>
	<p>USB 2.0 connectors — Connects up to two USB 2.0-compliant devices.</p>
	<p>AC Adapter connector — Connects an AC adapter to the media base and to AC power to convert AC power to the DC power required by the media base. You can connect the AC adapter with your media base either turned on or off. For more information, see Setting Up Your Media Base.</p> <p>CAUTION: If you are using a multiple-outlet power strip, use caution when you plug the AC adapter power cable into the power strip. Some power strips may allow you to insert the plug incorrectly. Incorrect insertion of the power plug could result in permanent damage to your media base, as well as risk of electric shock and/or fire. Ensure that you insert the ground prong of the power plug into the mating ground contact of the power strip.</p> <p>NOTICE: When you disconnect the AC adapter from the media base, hold the adapter cable connector, not the cable itself, and pull firmly but gently to avoid damaging the cable.</p>
	<p>IEEE 1394 connector — Connects devices supporting IEEE 1394 high-speed transfer rates, such as some digital cameras and video</p>

<div style="border: 1px solid black; padding: 5px; text-align: center; width: 60px; height: 30px; margin: 0 auto;">1394</div>	cameras
	<p>PS/2 connector — Connects PS/2-compatible devices such as a mouse, keyboard, or external numeric keypad.</p> <p>Shut down the computer before attaching a PS/2-compatible device. If the device does not work, install the device drivers from the floppy disk or CD that came with the device, and restart the computer.</p> <p>You can use the integrated keyboard and an external keypad at the same time. When you attach a PS/2 numeric keypad, the integrated keypad is disabled.</p>
	<p>headphone connector — Connects headphones or speakers. The connector is a stereo output connector.</p>

security cable slot — Lets you attach a commercially available antitheft device to the media base. Instructions for installing antitheft devices are usually included with the device. For more information, see [Securing the Media Base](#).

Top View

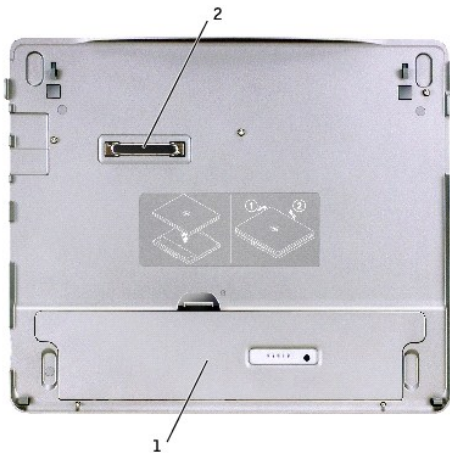

1	battery bay
2	docking connector

battery bay — Lets you charge a 28-WHr battery.

Bottom View

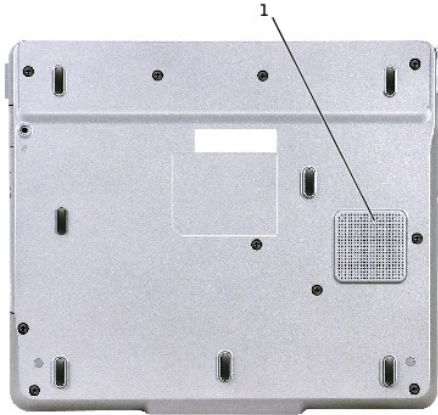

1	subwoofer
---	-----------

Setting Up Your Media Base

➡ **NOTICE:** Always use the Dell AC adapter that came with the media base. If you use any other commercially available AC adapter—or the AC adapter from older models of Dell computers— you may damage the media base or the computer.

1. Connect the AC adapter to the AC adapter connector and to an electrical outlet.



2. Before you initially dock your computer, the operating system must complete its setup process. To verify that the operating system has completed the setup process:
 - d. Ensure that the computer is not connected to the media base (docked).
 - e. Turn on the computer.
 - f. Verify that the Microsoft® Windows® desktop appears.
 - g. Shut down the computer through the Windows **Start** menu.
-

Securing the Media Base

🔒 **NOTE:** If the computer is docked to the media base and an antitheft device is attached to the security cable slot on the media base, you cannot undock the computer.



1	security cable slot
---	-------------------------------------

3. Attach a commercially available antitheft device to the security cable slot on the media base.

Antitheft devices usually include a segment of metal-stranded cable with an attached locking device and associated key. For instructions on installing this kind of antitheft device, see the documentation that accompanied the device.

Installing a Battery

To insert a battery into the battery bay:

1. Pull back the battery bay latch and lift up the [battery bay cover](#).

 **NOTE:** See the label inside the battery bay for instructions on inserting and removing a battery from the bay.

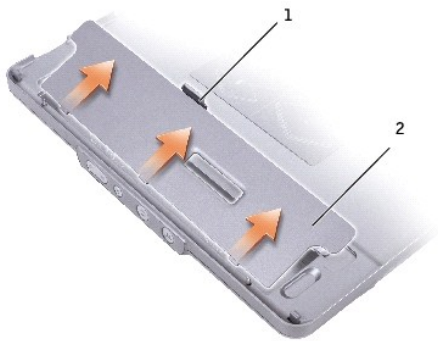

1	battery latch
---	---------------

2	battery bay cover
---	-------------------

2. Insert and press the battery into the battery bay until it clicks. Ensure that both the [battery latches](#) are engaged.
3. Replace the [battery bay cover](#).

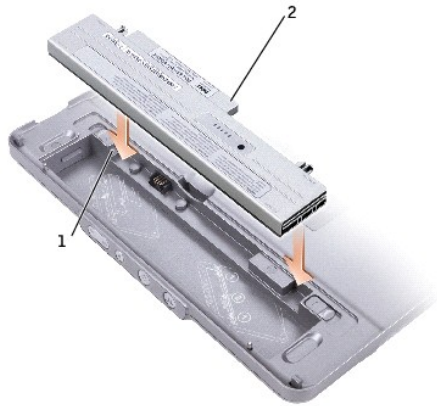

1	battery latch (2)
2	battery

To remove the battery from the battery bay:

1. Remove the [battery bay cover](#).
2. Slide both battery latches in the direction of the arrows, and remove the battery from the bay.

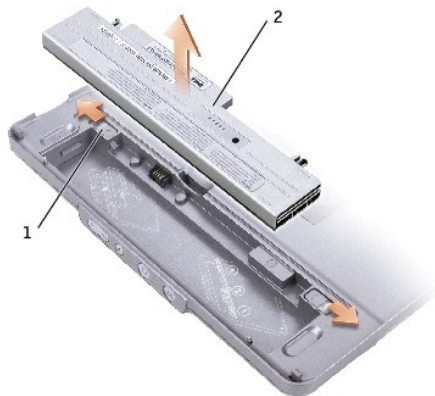

1	battery latch release (2)
2	battery

Docking Your Computer

 **NOTE:** If you are docking your computer for the first time and have not completed the steps in [Setting Up Your Media Base](#), complete them before proceeding to the next step.

 **NOTE:** After docking the computer for the first time, the computer battery or the computer AC adapter connection can power the media base if the media base is not connected to an AC adapter.

1. Align the front of the computer with the front of the media base and lower the computer onto the media base.

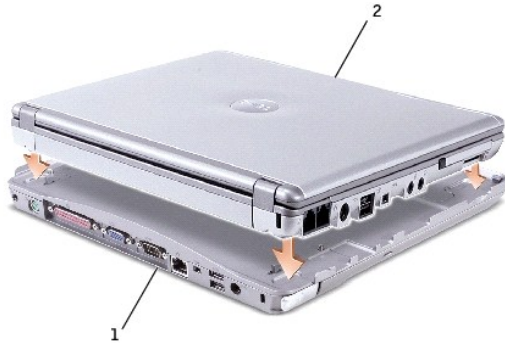

1	back of the media base
2	front of the computer

2. Gently press the computer into the media base until it clicks and the computer is seated.
3. Turn on the computer.

The operating system recognizes the media base.

 **NOTE:** Your computer should be turned off only when you dock your computer for the first time.

Undocking Your Computer

1. Before you undock your computer, save and close any open files and exit any open programs.
2. To set your computer's power management settings so that the computer does not enter standby or hibernate mode when you close (lower) the display:

Windows® XP

- a. Click the **Start** button and click **Control Panel**.
- b. Under **Pick a category**, click **Performance and Maintenance**.
- c. Under **or pick a Control Panel icon**, click **Power Options** and click the **Advanced** tab.
- d. Under the **When I close the lid of my portable computer** drop-down menu, select **Do nothing**.

Windows 2000

- a. Click the **Start** button, click **Settings** and then click **Control Panel**.
- b. Double-click the **Power Options** icon and click the **Advanced** tab.
- c. Under the **When I close the lid of my portable computer** drop-down menu, click **None**.

 **NOTICE:** Never undock the computer without first preparing the computer to undock. If you undock before preparing the computer, you will lose data and the computer may not recover normal operation for several minutes, if at all.

3. To prepare the computer for undocking, do one of the following:
 1. *In Windows XP*, click the **Start** button and then click **Undock Computer**.

In Windows 2000, click the **Start** button and click **Eject PC**.

An **Undock Complete** message appears, stating that you can now undock your computer, click **OK**.

OR

- 1 Press the undock button on the front of the media base for 1 second. (See "[Front View](#).")

An **Undock Complete** message appears stating that you can now undock your computer. Click OK.

4. If your media base is secured, remove the lock.
5. Pull the computer release lever (see "[Left Side View](#)") to release the computer.



6. Lift the computer out of the media base.

Installing Drives

1. Save and close any open files, and exit any open programs.
2. Insert the drive into the optical bay drive on the media base. (See "[Right Side View](#).")
3. The operating system recognizes the new drive.

Removing Drives

1. Save and close any open files, and exit any open programs.
2. Push the drive latch release and pull the drive out of the bay. (See "[Right Side View](#).")

Connecting and Disconnecting External Drives

- 1 To connect an external drive such as a floppy, CD, CD-RW, or DVD/CD-RW drive while the computer is off, connect the drive cable to the USB connector on the media base. (See "[Back View](#).")
- 1 To disconnect an external drive while the computer is off, remove the drive cable from the USB connector.
- 1 To connect and disconnect drives while the computer is running, see the following section, "[Swapping External Drives While the Computer Is Running](#)."

NOTICE: To prevent damage to external drives, place them in a safe, dry place when they are not connected to the computer. Avoid pressing down on them or placing heavy objects on top of them.

Swapping External Drives While the Computer Is Running

In Windows XP

1. Double-click the **Unplug or Eject Hardware** icon on the Windows taskbar.
2. Click the drive you want to eject.

3. Remove the drive cable from the USB connector.
4. Connect the new drive by connecting the drive cable to the USB connector.

The operating system recognizes the new drive.

If necessary, enter your password to unlock your computer.

In Windows 2000

1. Double-click the **Unplug or Eject Hardware** icon on the Windows taskbar.
2. Click the drive you want to eject and then click **Stop**.
3. Click **OK**, and wait until the drive you want to eject is cleared from the list of devices in the **Unplug or Eject Hardware** window.
4. Click **OK**.
5. Remove the drive cable from the USB connector.
6. Connect the new drive by connecting the drive cable to the USB connector.

The operating system recognizes the new drive.

Specifications

Physical	
Height	20 mm (0.79 inch)
Width	274.80 mm (10.82 inches)
Depth	235.70 mm (9.28 inches)
Weight (without optical drive)	0.84 kg (1.86 lb)

AC Adapter	
Input voltage	90–264 VAC
Input current (maximum)	1.2 A
Input frequency	47–63 Hz
Output current (maximum)	3.34 A
Output power	65 W
Rated output voltage	19.5 VDC
Dimensions :	
Height	27.94 mm (1.1 inches)
Width	58.42 mm (2.3 inches)
Depth	133.85 mm (5.25 inches)
Weight (including DC cable)	0.4 kg (0.9 lb)
Temperature range:	
Operating	0° to 35°C (32° to 95°F)
Storage	-40° to 65°C (-40° to 149°F)

Ports and Connectors	
Serial	9-pin connector: 16550C-compatible, 16-byte buffer connector
Parallel	25-hole connector: unidirectional, bidirectional, or ECP
USB	two 4-pin USB-compliant connectors
Video	15-hole connector
Audio	headphone/speakers (line-out) mini connector
PS/2	6-pin mini-DIN connector

IEEE 1394	4-pin connector
Docking	100-pin connector
Network adapter	RJ-45 port for 10/100/1000 Mbps/second BaseTX Bus Master Ethernet

[Back to Contents Page](#)

[Back to Contents Page](#)

Regulatory Notices

Dell™ Latitude™ X300 and Inspiron™ 300m Media Base User's Guide

- [FCC Notices \(U.S. Only\)](#)
- [IC Notice \(Canada Only\)](#)
- [CE Notice \(European Union\)](#)
- [CE Mark Notice](#)
- [ENERGY STAR® Compliance](#)
- [Simplified Chinese Class A Warning Notice \(China Only\)](#)
- [EN 55022 Compliance \(Czech Republic Only\)](#)
- [VCCI Notice \(Japan Only\)](#)
- [MIC Notice \(Republic of Korea Only\)](#)
- [Polish Center for Testing and Certification Notice](#)
- [BSMI Notice \(Taiwan Only\)](#)
- [NOM Information \(Mexico Only\)](#)

Electromagnetic Interference (EMI) is any signal or emission, radiated in free space or conducted along power or signal leads, that endangers the functioning of a radio navigation or other safety service or seriously degrades, obstructs, or repeatedly interrupts a licensed radio communications service. Radio communications services include but are not limited to AM/FM commercial broadcast, television, cellular services, radar, air-traffic control, pager, and Personal Communication Services (PCS). These licensed services, along with unintentional radiators such as digital devices, including media bases, contribute to the electromagnetic environment.

Electromagnetic Compatibility (EMC) is the ability of items of electronic equipment to function properly together in the electronic environment. While this media base has been designed and determined to be compliant with regulatory agency limits for EMI, there is no guarantee that interference will not occur in a particular installation. If this equipment does cause interference with radio communications services, which can be determined by turning the equipment off and on, you are encouraged to try to correct the interference by one or more of the following measures:

- 1 Reorient the receiving antenna.
- 1 Relocate the media base with respect to the receiver.
- 1 Move the media base away from the receiver.
- 1 Plug the media base into a different outlet so that the computer and the receiver are on different branch circuits.

If necessary, consult a Dell Technical Support representative or an experienced radio/television technician for additional suggestions.

Dell™ media bases are designed, tested, and classified for their intended electromagnetic environment. These electromagnetic environment classifications generally refer to the following harmonized definitions:

- 1 Class A is typically for business or industrial environments.
- 1 Class B is typically for residential environments.

Information Technology Equipment (ITE), including devices, expansion cards, printers, input/output (I/O) devices, monitors, and so on, that are integrated into or connected to the media base should match the electromagnetic environment classification of the media base.

A Notice About Shielded Signal Cables: Use only shielded cables for connecting devices to any Dell device to reduce the possibility of interference with radio communications services. Using shielded cables ensures that you maintain the appropriate EMC classification for the intended environment. For parallel printers, a cable is available from Dell. If you prefer, you can order a cable from Dell on the World Wide Web at accessories.us.dell.com/sna/category.asp?category_id=4117.

Most Dell computers are classified for Class B environments. However, the inclusion of certain options can change the rating of some configurations to Class A. To determine the electromagnetic classification for your computer or device, see the following sections specific for each regulatory agency. Each section provides country-specific EMC/EMI or product safety information.

FCC Notices (U.S. Only)

Most Dell computers are classified by the Federal Communications Commission (FCC) as Class B digital devices. To determine which classification applies to your computer, examine all FCC registration labels located on the bottom, side, or back panel of your computer, on card-mounting brackets, and on the cards themselves. If any one of the labels carries a Class A rating, your entire computer is considered to be a Class A digital device. If *all* labels carry an FCC Class B rating as distinguished by either an FCC ID number or the FCC logo, (), your computer is considered to be a Class B digital device.

Once you have determined your computer's FCC classification, read the appropriate FCC notice. Note that FCC regulations provide that changes or modifications not expressly approved by Dell could void your authority to operate this equipment.

This device complies with Part 15 of the FCC Rules. Operation is subject to the following two conditions:

- 1 This device may not cause harmful interference.
- 1 This device must accept any interference received, including interference that may cause undesired operation.

Class A

This equipment has been tested and found to comply with the limits for a Class A digital device pursuant to Part 15 of the FCC Rules. These limits are designed to provide reasonable protection against harmful interference when the equipment is operated in a commercial environment. This equipment generates, uses, and can radiate radio frequency energy and, if not installed and used in accordance with the manufacturer's instruction manual, may cause harmful interference with radio communications. Operation of this equipment in a residential area is likely to cause harmful interference, in which case you will be required to correct the interference at your own expense.

Class B

This equipment has been tested and found to comply with the limits for a Class B digital device pursuant to Part 15 of the FCC Rules. These limits are designed to provide reasonable protection against harmful interference in a residential installation. This equipment generates, uses, and can radiate radio frequency energy and, if not installed and used in accordance with the manufacturer's instruction manual, may cause interference with radio communications. However, there is no guarantee that interference will not occur in a particular installation. If this equipment does cause harmful interference to radio or television reception, which can be determined by turning the equipment off and on, you are encouraged to try to correct the interference by one or more of the following measures:

- 1 Reorient or relocate the receiving antenna.
- 1 Increase the separation between the equipment and the receiver.
- 1 Connect the equipment into an outlet on a circuit different from that to which the receiver is connected.
- 1 Consult the dealer or an experienced radio/television technician for help.

FCC Identification Information

The following information is provided on the device or devices covered in this document in compliance with FCC regulations:

- 1 Model number: PR04S
- 1 Company name:

Dell Computer Corporation
One Dell Way
Round Rock, Texas 78682 USA
512-338-4400

IC Notice (Canada Only)

Most Dell computers (and other Dell digital apparatus) are classified by the Industry Canada (IC) Interference-Causing Equipment Standard #3 (ICES-003) as Class B digital devices. To determine which classification (Class A or B) applies to your computer (or other Dell digital apparatus), examine all registration labels located on the bottom, side, or the back panel of your computer (or other digital apparatus). A statement in the form of "IC Class A ICES-003" or "IC Class B ICES-003" will be located on one of these labels. Note that Industry Canada regulations provide that changes or modifications not expressly approved by Dell could void your authority to operate this equipment.

This Class B (or Class A, if so indicated on the registration label) digital apparatus meets the requirements of the Canadian Interference-Causing Equipment Regulations.

Cet appareil numérique de la Classe B (ou Classe A, si ainsi indiqué sur l'étiquette d'enregistrement) respecte toutes les exigences du Règlement sur le Matériel Brouilleur du Canada.

CE Notice (European Union)

Marking by the symbol **CE** indicates compliance of this Dell computer to the EMC Directive and the Low Voltage Directive of the European Union. Such marking is indicative that this Dell system meets the following technical standards:

- 1 EN 55022 — "Information Technology Equipment — Radio Disturbance Characteristics — Limits and Methods of Measurement."
- 1 EN 55024 — "Information Technology Equipment - Immunity Characteristics - Limits and Methods of Measurement."
- 1 EN 61000-3-2 — "Electromagnetic Compatibility (EMC) - Part 3: Limits - Section 2: Limits for Harmonic Current Emissions (Equipment Input Current Up to and Including 16 A Per Phase)."
- 1 EN 61000-3-3 — "Electromagnetic Compatibility (EMC) - Part 3: Limits - Section 3: Limitation of Voltage Fluctuations and Flicker in Low-Voltage Supply Systems for Equipment With Rated Current Up to and Including 16 A."
- 1 EN 60950 — "Safety of Information Technology Equipment."

NOTE: EN 55022 emissions requirements provide for two classifications:

- 1 Class A is for typical commercial areas.
- 1 Class B is for typical domestic areas.

RF INTERFERENCE WARNING: This is a Class A product. In a domestic environment this product may cause radio frequency (RF) interference, in which case the user may be required to take adequate measures.

This Dell device is classified for use in a typical Class B domestic environment.

A "Declaration of Conformity" in accordance with the preceding directives and standards has been made and is on file at Dell Computer Corporation Products Europe BV, Limerick, Ireland.

CE Mark Notice

This equipment complies with the essential requirements of the European Union Directive 1999/5/EC.

Cet équipement est conforme aux principales caractéristiques définies dans la Directive européenne RTTE 1999/5/CE.

Die Geräte erfüllen die grundlegenden Anforderungen der R11E-Hochlinie (1999/5/EG).

Questa apparecchiatura è conforme ai requisiti essenziali della Direttiva Europea R&TTE 1999/5/CE.

Este equipo cumple los requisitos principales de la Directiva 1999/5/CE de la UE, "Equipos de Terminales de Radio y Telecomunicaciones".

Este equipamento cumpre os requisitos essenciais da Directiva 1999/5/CE do Parlamento Europeu e do Conselho (Directiva RTT).

Ο εξοπλισμός αυτός πληροί τις βασικές απαιτήσεις της κοινοτικής οδηγίας EU R&TTE 1999/5/ΕΚ.

Deze apparatuur voldoet aan de noodzakelijke vereisten van EU-richtlijn betreffende radioapparatuur en telecommunicatie-omroepapparatuur 1999/5/EG.

Detle udstyr opfylder de væsentlige krav i EU's direktiv 1999/5/EC om Radio- og teleterminaludstyr.

Detle udstyr er i overensstemmelse med hovedkravene i R&TTE-direktivet (1999/5/EC) fra EU.

Utrustningen uppfyller kraven för EU-direktivet 1999/5/EC om anslutna teleutrustning och ömsesidigt erkännande av utrustningens överensstämmelse (R&TTE).

Tämä laite vastaa EU:n radio- ja telepäätelaitteiden direktiivin (EU R&TTE Directive 1999/5/EC) vaatimuksia.

ENERGY STAR® Compliance

Certain configurations of Dell computers comply with the requirements set forth by the Environmental Protection Agency (EPA) for energy-efficient computers. If the front panel of your computer bears the ENERGY STAR® Emblem, your original configuration complies with these requirements and all ENERGY STAR® power management features of the computer are enabled.

NOTE: Any Dell computer bearing the ENERGY STAR® Emblem is certified to comply with EPA ENERGY STAR® requirements as configured when shipped by Dell.

Any changes you make to this configuration (such as installing additional expansion cards or drives) may increase the computer's power consumption beyond the limits set by the EPA's ENERGY STAR® Computers program.



The EPA's ENERGY STAR® Computers program is a joint effort between the EPA and computer manufacturers to reduce air pollution by promoting energy-efficient computer products. The EPA estimates that use of ENERGY STAR® computer products can save computer users up to two billion dollars annually in electricity costs. In turn, this reduction in electricity usage can reduce emissions of carbon dioxide, the gas primarily responsible for the greenhouse effect, and sulfur dioxide and nitrogen oxides, the primary causes of acid rain.

You can also help reduce electricity usage and its side effects by turning off your computer when it is not in use for extended periods of time, particularly at night and on weekends.

Simplified Chinese Class A Warning Notice (China Only)

On Class A systems, the following warning will appear near the regulatory label:

Warning: This is a Class A product. In a domestic environment this product may cause radio interference, in which case the user may be required to take adequate measures.

声明

此为 A 级产品，在生活环境中，该产品可能会造成无线电干扰。
在这种情况下，可能需要用户对其干扰采取切实可行的措施。

EN 55022 Compliance (Czech Republic Only)

This device belongs to Class B devices as described in EN 55022, unless it is specifically stated that it is a Class A device on the specification label. The following applies to devices in Class A of EN 55022 (radius of protection up to 30 meters). The user of the device is obliged to take all steps necessary to remove sources of interference to telecommunication or other devices.

Pokud není na typovém štítku počítače uvedeno, že spadá do třídy A podle EN 55022, spadá automaticky do třídy B podle EN 55022. Pro zařízení zařazená do třídy A (ochranné pásmo 30m) podle EN 55022 platí následující. Dojde-li k rušení telekomunikačních nebo jiných zařízení, je uživatel povinen provést taková opatření, aby rušení odstranil.

VCCI Notice (Japan Only)

Most Dell computers are classified by the Voluntary Control Council for Interference (VCCI) as Class B information technology equipment (ITE). However, the inclusion of certain options can change the rating of some configurations to Class A. ITE, including devices, expansion cards, printers, input/output (I/O) devices, monitors, and so on, integrated into or connected to the computer should match the electromagnetic environment classification (Class A or B) of the computer.

To determine which classification applies to your computer, examine the regulatory labels/markings (see "VCCI Class A ITE Regulatory Mark" and "VCCI Class B

ITE Regulatory Mark") located on the bottom, side, or back panel of your computer. Once you have determined your computer's VCCI classification, read the appropriate VCCI notice.

Class A ITE

この装置は、情報処理装置等電波障害自主規制協議会(VCCI)の基準に基づくクラス A 情報技術装置です。この装置を家庭環境で使用すると電波妨害を引き起こすことがあります。この場合には使用者が適切な対策を講ずるよう要求されることがあります。

This is a Class A product based on the standard of the Voluntary Control Council for Interference (VCCI) for information technology equipment. If this equipment is used in a domestic environment, radio disturbance may arise. When such trouble occurs, the user may be required to take corrective actions.

VCCI Class A ITE Regulatory Mark

If the regulatory label includes the following marking, your computer is a Class A product:

VCCI

Class B ITE

この装置は、情報処理装置等電波障害自主規制協議会(VCCI)の基準に基づくクラス B 情報技術装置です。この装置は家庭環境で使用することを目的としています。ラジオやテレビジョン受信機に近接して使用されると、受信障害を引き起こすことがあります。取扱説明書に従って正しい取り扱いをしてください。

This is a Class B product based on the standard of the Voluntary Control Council for Interference (VCCI) for information technology equipment. If this equipment is used near a radio or television receiver in a domestic environment, it may cause radio interference. Install and use the equipment according to the instruction manual.

VCCI Class B ITE Regulatory Mark

If the regulatory label includes the following marking, your computer is a Class B product:



MIC Notice (Republic of Korea Only)

To determine which classification (Class A or B) applies to your computer (or other Dell digital device), examine the Republic of Korean Ministry of Information and Communications (MIC) registration labels located on your computer (or other Dell digital device). The MIC label may be located separately from the other regulatory marking applied to your product. Line two of the label identifies the emissions class for the product—"A" for Class A products or "B" for Class B

products.

NOTE: MIC emissions requirements provide for two classifications:

- 1 Class A devices are for business purposes.
- 1 Class B devices are for nonbusiness purposes.

Class A Device

기종별	사용자 안내문
A급 기기 (업무용 정보통신기기)	이 기기는 업무용으로 전자파적합등록을 한 기기이오니 판매자 또는 사용자는 이 점을 주의하시기 바라며 만약 잘못 판매 또는 구입하였을 때에는 가정용으로 교환하시기 바랍니다.

Please note that this device has been approved for business purposes with regard to electromagnetic interference. If you find that this device is not suitable for your use, you may exchange it for a nonbusiness-purpose device.

MIC Class A Regulatory Label

If the regulatory label includes the following marking, your computer is a Class A product:



1. 기기의 명칭(모델명):
2. 인증번호:(A)
3. 인증받은 자의 상호:
4. 제조년월일:
5. 제조자/제조국가:

Class B Device

기종별	사용자 안내문
B급 기기 (가정용 정보통신기기)	이 기기는 가정용으로 전자파적합등록을 한 기기로서 주거지역에서는 물론 모든 지역에서 사용할 수 있습니다.

Please note that this device has been approved for nonbusiness purposes and may be used in any environment, including residential areas.

MIC Class B Regulatory Label

If the regulatory label includes the following marking, your computer is a Class B product:



1. 기기의 명칭(모델명):
2. 인증번호:(B)
3. 인증받은 자의 상호:
4. 제조년월일:
5. 제조자/제조국가:

Polish Center for Testing and Certification Notice

The equipment should draw power from a socket with an attached protection circuit (a 3-prong socket). All equipment that works together (computer, monitor, printer, and so on) should have the same power supply source.

The phasing conductor of the room's electrical installation should have a reserve short-circuit protection device in the form of a fuse with a nominal value no larger than 16 amperes (A).

To completely switch off the equipment, the power supply cable must be removed from the power supply socket, which should be located near the equipment and easily accessible.

A protection mark "B" confirms that the equipment is in compliance with the protection usage requirements of standards PN-93/T-42107 and PN-EN 55022.

Wymagania Polskiego Centrum Badań i Certyfikacji

Urządzenie powinno być zasilane z gniazda z przyłączonym obwodem ochronnym (gniazdo z kołkiem). Współpracujące ze sobą urządzenia (komputer, monitor, drukarka) powinny być zasilane z tego samego źródła.

Instalacja elektryczna pomieszczenia powinna zawierać w przewodzie fazowym rezerwową ochronę przed zwarciami, w postaci bezpiecznika o wartości znamionowej nie większej niż 16A (amperów).



W celu całkowitego wyłączenia urządzenia z sieci zasilania, należy wyjąć wtyczkę kabla zasilającego z gniazodka, które powinno znajdować się w pobliżu urządzenia i być łatwo dostępne. Znak bezpieczeństwa "B" potwierdza zgodność urządzenia z wymaganiami bezpieczeństwa użytkownika zawartymi w *PN-EN 60950:2000* i *PN-EN 55022:2000*.

Jeżeli na tabliczce znamionowej umieszczono informację, że urządzenie jest klasy A, to oznacza to, że urządzenie w środowisku mieszkalnym może powodować zakłócenia radioelektryczne. W takich przypadkach można żądać od jego użytkownika zastosowania odpowiednich środków zaradczych.

Pozostałe instrukcje bezpieczeństwa

- Nie należy używać wtyczek adapterowych lub usuwać kołka obwodu ochronnego z wtyczki. Jeżeli konieczne jest użycie przedłużacza to należy użyć przedłużacza 3-żyłowego z prawidłowo połączonym przewodem ochronnym.
 - System komputerowy należy zabezpieczyć przed nagłymi, chwilowymi wzrostami lub spadkami napięcia, używając eliminatora przepięć, urządzenia dopasowującego lub bezzakłócenowego źródła zasilania.
 - Należy upewnić się, aby nic nie leżało na kablach systemu komputerowego, oraz aby kable nie były umieszczone w miejscu, gdzie można byłoby na nie nadeptywać lub połykać się o nie.
 - Nie należy rozlewać napojów ani innych płynów na system komputerowy.
 - Nie należy wpychać żadnych przedmiotów do otworów systemu komputerowego, gdyż może to spowodować pożar lub porażenie prądem, poprzez zwarcie elementów wewnętrznych.
 - System komputerowy powinien znajdować się z dala od grzejników i źródeł ciepła. Ponadto, nie należy blokować otworów wentylacyjnych. Należy unikać kładzenia luźnych papierów pod komputer oraz umieszczania komputera w ciasnym miejscu bez możliwości cyrkulacji powietrza wokół niego.
-

BSMI Notice (Taiwan Only)

If you find a  or  mark on the regulatory

label on the bottom, side, or back panel of your computer, the following section is applicable:

BSMI 通告 (僅限於台灣)

大多數的 Dell 電腦系統被 BSMI (經濟部標準檢驗局) 劃分為乙類數位裝置。但是，使用某些選件會使有些組態的等級變成甲類。若要確定您的電腦系統適用等級，請檢查所有位於電腦底座或背面板、擴充卡安裝托架，以及擴充卡上的 BSMI 註冊標籤。如果其中有一甲類標籤，即表示您的系統為甲類數位裝置。如果只有 BSMI 的檢驗號碼標籤，則表示您的系統為乙類數位裝置。

一旦確定了系統的 BSMI 等級，請閱讀相關的 BSMI 通告。請注意，BSMI 通告規定凡是未經 Dell Computer Corporation 明確批准的擅自變更或修改，將導致您失去此設備的使用權。

此裝置符合 BSMI (經濟部標準檢驗局) 的規定，使用時須符合以下兩項條件：

- 此裝置不會產生有害干擾。
- 此裝置必須能接受所接收到的干擾，包括可能導致無法正常作業的干擾。

甲類

此設備經測試證明符合 BSMI (經濟部標準檢驗局) 之甲類數位裝置的限制規定。這些限制的目的是為了在商業環境中使用此設備時，能提供合理的保護以防止有害的干擾。此設備會產生、使用並散發射頻能量；如果未遵照製造廠商的指導手冊來安裝和使用，可能會干擾無線電通訊。請勿在住宅區使用此設備。

警告使用者：
這是甲類的資訊產品，在居住的環境中使用時，可能會造成射頻干擾，在這種情況下，使用者會被要求採取某些適當的對策。

乙類

此設備經測試證明符合 BSMI (經濟部標準檢驗局) 之乙類數位裝置的限制規定。這些限制的目的是為了在住宅區安裝時，能防止有害的干擾，提供合理的保護。此設備會產生、使用並散發射頻能量；如果未遵照製造廠商的指導手冊來安裝和使用，可能會干擾無線電通訊。但是，這並不保證在個別的安装中不會產生干擾。您可以透過關閉和調降此設備來判斷它是否會對廣播和電視收訊造成干擾；如果確實如此，我們建議您嘗試以下列一種或多種方法來排除干擾：

- 重新調整天線的接收方向或重新放置接收天線。
- 增加設備與接收器的距離。
- 將設備連接至不同的插座，使設備與接收器連接在不同的電路上。
- 請向經銷商或有經驗的無線電/電視技術人員查詢，以獲得幫助。

NOM Information (Mexico Only)

The following information is provided on the device(s) described in this document in compliance with the requirements of the official Mexican standards (NOM):

Exporter:	Dell Computer Corporation One Dell Way Round Rock, TX 78682
Importer:	Dell Computer de México, S.A. de C.V. Paseo de la Reforma 2620 - 11º Piso Col. Lomas Altas 11950 México, D.F.
Ship to:	Dell Computer de México, S.A. de C.V. al Cuidado de Kuehne & Nagel de México S. de R.L. Avenida Soles No. 55 Col. Peñon de los Baños 15520 México, D.F.

Model number:	PR04S
Supply voltage:	100-240 VAC
Frequency:	50-60 Hz
Current Consumption:	1.5 A
Output voltage:	19.5 A
Output current:	3.34 A

[Back to Contents Page](#)

[Back to Contents Page](#)

Limited Warranty and Return Policy

Dell™ Latitude™ X300 and Inspiron™ 300m Media Base User's Guide

Dell Computer Corporation ("Dell") manufactures its hardware products from parts and components that are new or equivalent to new in accordance with industry-standard practices. For information about the Dell limited warranty for your media base, see the printed documentation that came with your computer.

[Back to Contents Page](#)